



Carlin®

Combustion Technology, Inc.

Model 40200/42230 CAD Cell Oil Primary Control Data Sheet

- **Oil Pump Bleed Assist**
Up to 1 min.
- **Recycle on Flame Failure**
- **Serviceman Reset Protection**
Latch-up after 3 consecutive lockouts
- **Diagnostic LEDs**
Status, lockout, flame
- **15-second, 30-second TFI**
- **Increased Flame Accuracy**
- **Thermostat/Aquastat Compatible**
- **Improved SMC Technology**
Zero bleed voltage during standby
- **Works Well with Generators**
Insensitive to frequency changes
- **Flame Stabilize**

Power input (from limit circuit)	120 VAC, 60 HZ, 10 VA
Motor load	10 FLA / 60 LRA
Ignitor load	120 VAC, 60 HZ, 500 VA
Operating temperature limits	+32°F to +140°F

Storage temperature limits	-40°F to +185°F
Thermostat anticipator current	0.1 A, AC
CAD cell resistance (with flame)	R < 1500 OHMS
Agencies	UL recognized (US & Canada)

Installing and Wiring

WARNING 40200 and 42230 controls must be installed and serviced only by a qualified service technician.

1. Always disconnect power source before wiring to avoid electrical shock or damage to the control. All wiring must comply with applicable codes and ordinances.
2. Thermostat terminals (T-T) provide a current source. Never apply external power to these terminals under any circumstances.

Mounting

- The control may be mounted on a 4" x 4" junction box in any convenient location on the burner, furnace or wall. The location must not exceed the ambient temperature limit, 140°F.

Wiring

- Wiring must comply with local and national electrical codes, and with the wiring diagram.
- Individual or bundled neutrals may be attached to any L2 terminal.

Field checks

1. **Safety timing (TFI) test** – Remove one cad cell wire (F-F). Start burner. The control should lockout within the TFI time limit. Replace cad cell wire.
2. **Flame failure test** – Start burner. After flame is established (after TFI period), close the oil supply hand valve. This will cause a flame failure sequence as described in the Startup & Operation section of this Data sheet. The control should recycle (restart after 65 seconds).
3. If control does not operate as described, check the wiring.



SEE WIRING DIAGRAM ON NEXT PAGE

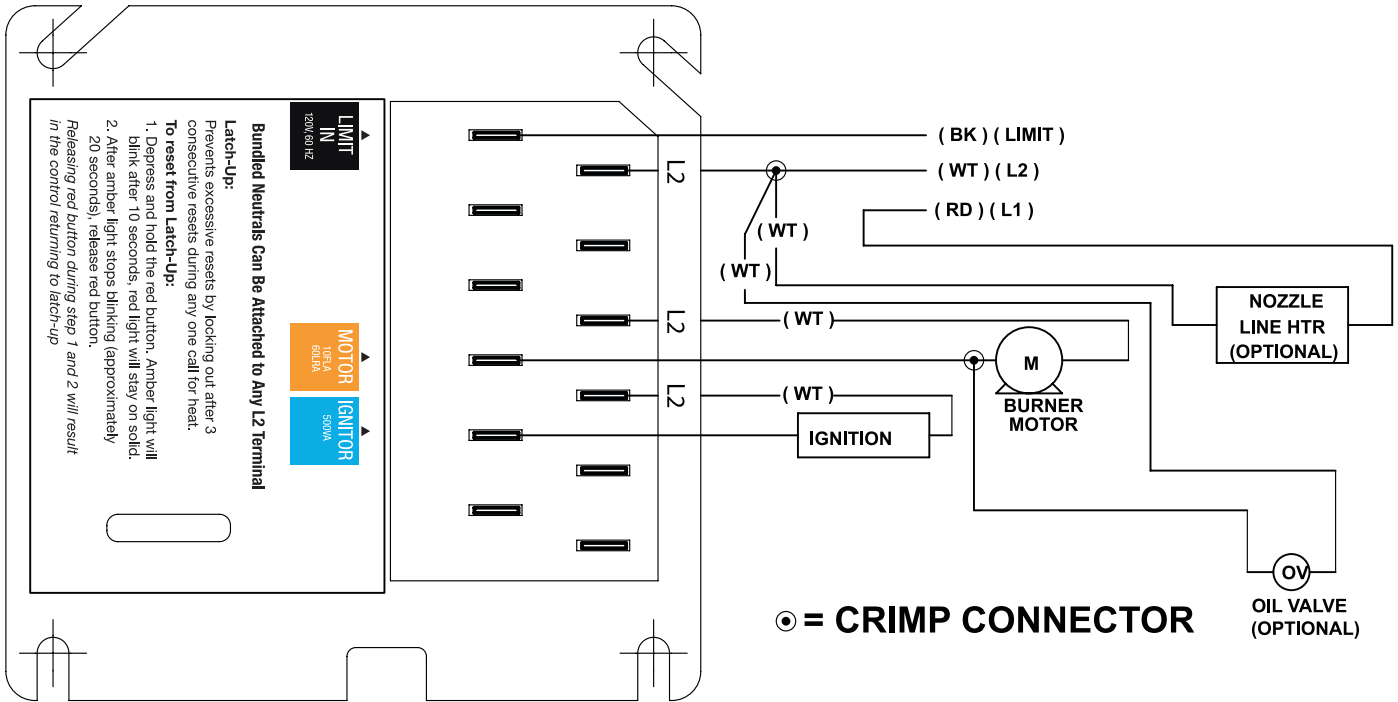







Wiring

















































Start-up & Operation

WARNING Do not start the burner if the combustion chamber contains oil or oil vapor.

NOTICE Per UL requirements, the control will not turn on if the CAD cell senses flame during the self-test. If the CAD cell sees light (flame) at the beginning of a cycle, the control will remain in self-test mode until the CAD cell no longer senses light (flame). The amber LED will blink momentarily  every 3 to 4 seconds and green LED will be on  or flashing .

Model 40200 & 42230 Diagnostic LEDs		
 – Amber OFF	 – Amber ON	 – Amber FLASHING
 – Green OFF	 – Green ON	 – Green FLASHING
 – Red OFF	 – Red ON	 – Red FLASHING

-    **Power ON** Open all manual oil line valves. Close the line switch.
-    **Self-test 1** The control performs a “boot-up” test to verify internal operation each time power is applied to the black wire. The amber LED turns on and the test continues for about 5 seconds. If the test fails, the control turns the amber LED off and repeats this test sequence until successful.
-    **Stand-by** (No call for heat) If Self-test 1 is successful, amber LED turns off and control waits for heat call.
-    **Call for heat** Set thermostat and limit to call for heat. Thermostat circuit must be closed and power coming to black wire from limit circuit.
- Self-test 2** If a failure occurs in this self-check, the control won't start and the amber LED blinks 1 second on, 4 seconds off, until serviced or the problem clears. These failures include CAD cell seeing light, internal fault, or line voltage <90V. See service section.
-    **Burner on** After the self-test, amber LED turns off. The ignitor starts, followed 2 seconds later by the motor.
-    **Pump Prime** To enter pump prime: 1. Start a CFH cycle. During Pre-Ignition, press Reset. Motor turns off (10 seconds), then release the button. When motor turns back on, within 5 seconds, press the Reset button until the amber LED starts to flash. You are in Pump Prime, release Reset button.
Optional Pump Prime notes: 1) If lost, press Reset for 1 second and release, then if the control is not in Pump Prime, restart the sequence. 2) If Reset is released before end of first 10 seconds, the control returns to Standby and restarts another CFH cycle. 3) If reset is not pressed the second time, a normal CFH cycle will continue. 4) If motor and ignitor are on and amber LED is flashing, the control is in Pump Prime. 5) Pump Prime will exit standby if flame is detected, or 60 seconds has elapsed, or loss of TT or Limit, or Reset button is pressed.
-    **TFI** The CAD cell must sense flame within the TFI time limit (trial for ignition). Insufficient flame puts control into lockout.
-    **Run** The burner continues firing during call for heat if the CAD cell is sensing flame. Only the green LED is on during normal running.
-    **Lockout** If CAD cell does not sense flame within the TFI time limit after the burner starts, lockout occurs. The control turns the red LED on constant, and closes the alarm contact.
- To Reset** Push in and hold reset button for 2 seconds, then release.
-    **Latch-up** If the control locks out 3 times during a single call for heat, latch-up occurs. The control turns on both the amber and red LEDs constant. You must use the special procedure below to reset the control after latch-up.
-  **Reset after latch-up:** Only a qualified service technician should attempt to reset the control after latchup. The problem that caused the repeated burner lockouts must be corrected before returning the burner to normal operation.
-    **To Reset** Push in and hold the reset button for 10 seconds. The amber LED will begin to flash.
-    After the LED begins flashing, continue holding the reset button for 20 seconds. The LEDs will turn off. Release the reset button and the control will restart (releasing the button before the LEDs turn off will cause the control to remain in latch-up).
- NOTICE** The 40200 & 42230 controls will retain lockout or latchup if power is interrupted.
-    **Flame Failure** If the CAD cell loses flame signal during operation (after the TFI), the red LED flashes. Recycle: Control waits for 65 seconds (with red LED flashing), then begins again at Self-test 2. Red LED goes off .
-    **NOTICE** If the green LED is blinking during a run, the flame is weak or unstable which may cause recycle.
-    **Stand-by** Control remains in stand-by mode until limit circuit sends power to the black wire and thermostat circuit closes (call for heat).

Service & Troubleshooting

Burner (control) will not come on

ⓐ ⓑ ⓓ No power to control

- Check limit circuit to the control (at least 102 VAC).
- Check all electrical connections.

ⓐ ⓑ ⓓ Control is in lockout

- Red LED will be on. Press the reset button for 2 seconds.

ⓐ ⓑ ⓓ CAD cell seeing light

- Green LED on, and amber LED blinking 1 second on, 4 seconds off. Remove one yellow lead from FF terminals, and the flame test plug. If the amber LED remains flashing, the control is defective.

If the amber LED goes OFF, the control is OK, and;

- light is leaking into the burner housing, or
- CAD cell is defective, or
- there is a problem with the CAD cell wiring or holder.
- If appliance was recently shut down, CAD cell may see residual hot spots in chamber.

To troubleshoot:

- Attach multimeter to monitor CAD cell resistance. Dark resistance should be over 50K ohms, and room light resistance (control flipped open) should be at most 10K ohms. Replace cell if necessary, or reinstall and close the burner housing.
- Check for stray light by measuring the CAD cell resistance looking into the inactive combustion chamber. It should read at least 50 kohms.

ⓐ ⓑ ⓓ Other no start problems

If the CAD cell is OK, and the amber LED still blinks 1 second on, 4 seconds off, the other possible failures include:

- Line voltage <90 VAC (amber LED flashes uniquely, 1 second on, 1/2 second off, 1 second on, 3 seconds off, then repeats). *Check line voltage.*
- Internal fault. CAD cell and line voltage OK. The issue may be an internal fault. *Replace the control.*

Repeated flame failures (ⓐ ⓑ ⓓ flashing red LED)

Check for:

- CAD cell is defective. *Replace.*
- Air leaking into oil line causing flame out. *Check oil line connections and filter gasket.*
- Defective nozzle causing flame to be erratic. *Change nozzle.*
- Excessive airflow or draft causing flame to leave burner head. *Check for proper air band setting and draft.*
- Excessive back pressure causing flame to be erratic. *Check appliance and flue for sooting/plugging.*

Control locks out at end of TFI (ⓐ ⓑ ⓓ red LED on)

Check for:

- No oil to burner. *Check oil supply, filters, lines.*
- Shorted electrodes. *Inspect for cracked porcelain and replace as needed.*
- Poor spark. Check electrode spacing and condition per burner manual. *Replace or realign if necessary.*
- Nozzle clogged. *Replace nozzle.*
- Airflow too high. *Check air band setting.*
- Ignitor module defective. *Replace if no spark.*
- CAD cell defective
- Oil valve (if used) stuck in closed position.
- Check wiring connections.

ⓐ ⓑ ⓓ Blinking Green LED

- Weak or unstable flame.
- Check ohms.
- Check CO₂ level.

NOTICE

FROZEN PIPES/WATER DAMAGE: This is not a freeze protection device. Suitable freeze protection monitoring or other precautions are recommended to protect against ruptured pipes/water damage caused by fuel outage, safety related fault conditions, or equipment failures.