

- **More Efficient** —
  - both starting and running

- **More Reliable** —
  - auto reset thermal overload
  - **quiet** sealed ball bearings
  - eliminates centrifugal start switch
  - 5-year warranty
  - UL recognized

- **More Versatile** —
  - replace 1/15 to 1/4 HP motors
  - replaceable capacitor

# PSC Motors

Models 98022, 98611, 98627, 98628  
98629, 98630, 98866, 99220

## Data Sheet

### Installing and Wiring

**WARNING** Carlin PSC motors must be installed and serviced only by a qualified service technician.

1. Always disconnect power source before wiring to avoid electrical shock or damage to the electrical components. All wiring must comply with applicable codes and ordinances.
2. Disconnect existing motor lead wires from control wiring. Release motor lead wire strain relief bushing at junction box entrance. Pull wire from junction box.
3. Remove mounting bolts securing existing motor to blower housing.
4. Remove motor from burner.
5. Oil burners: Check condition of oil pump coupling and coupling ends. Replace if necessary.
6. Remove blower wheel from existing motor. (Clean the wheel if needed to remove lint and other debris.)
7. Install blower wheel on the new Carlin PSC motor. See burner manual for correct gap between blower wheel and motor rabbet.
8. Mount new motor on blower housing. Tighten bolts evenly to prevent misalignment of the motor/blower wheel on housing.
9. Insert motor wires through strain relief bushing and connect to control wires.

### Application Tips

1. Use Carlin PSC motors for all replacement motors on oil and gas burners.
2. The Carlin PSC motor design allows air to flow through the motor into the blower housing, providing necessary cooling.
3. The high running torque of the PSC design ensures more consistent air flow to the burner head. **Perform a combustion test with the new motor installed, and set the air adjustments as needed to provide the CO<sub>2</sub> (O<sub>2</sub>) specified in the appliance manual.**
4. Thermal overload — Overload will trip after approximately 3 minutes of running at locked rotor condition. Switch will cool and reset automatically.

|  |                     |           |           |                  |            |            |            |           |
|--|---------------------|-----------|-----------|------------------|------------|------------|------------|-----------|
| Part number:                           | 98022               | 98611     | 98627     | 98628            | 98629      | 98630      | 98866      | 99220     |
| Power input (VAC, 1-PHASE)             | 120                 | 120       | 230       | 120              | 120        | 120        | 120        | 230       |
| Frequency (HZ)                         | 60                  | 60        | 50/60     | 60               | 60         | 60         | 60         | 50        |
| Rating (HP)                            | 1/6                 | 1/6       | 1/6       | 1/6              | 1/15       | 1/4        | 1/6        | 1/4       |
| Starting/running currents (AMPS RMS)   | 6.1 / 1.8           | 6.1 / 1.8 | 1.0       | 6.1 / 1.8        | 4.3 / 1.25 | 12.1 / 2.7 | 4.3 / 1.25 | 1.3       |
| Speed (RPM)                            | 3450                | 3450      | 2840/3390 | 3450             | 3450       | 3450       | 1725       | 2800      |
| Frame                                  | 48M                 | 48N       | 48M       | 48N5             | 48M        | 48N        | 48N        | 48N       |
| Lead length (INCHES)                   | 10                  | 10        | 10        | 20               | 10         | 10         | 10         | 10        |
| Rotation (LOOKING FROM REAR)           | clockwise           | clockwise | clockwise | counterclockwise | clockwise  | clockwise  | clockwise  | clockwise |
| Capacitor location (LOOKING FROM REAR) | 9:00                | 9:00      | 9:00      | 6:00             | 9:00       | 9:00       | 9:00       | 9:00      |
| Capacitor (µF)                         | 16                  | 16        | 5         | 16               | 12.5       | 25         | 14         | 6.3       |
| Part number                            | 98022CAP            | 98022CAP  | 98627CAP  | 98022CAP         | 98629CAP   | 98630CAP   | 98866CAP   | 99220CAP  |
| Agencies                               | UL & CUL recognized |           |           |                  |            |            |            |           |

**Construction**

- All Carlin PSC motors are cast aluminum and Class A insulation.
- The Carlin PSC Motor utilizes a capacitor to assist startup and run of the motor. This eliminates the need for a start switch used in the split phase motor. The Carlin motor capacitor is field replaceable for ease of service.
- The Carlin PSC Motor has sealed ball bearings – not sleeve bearings. The ball bearings are sealed and permanently lubricated – no oiling required. Ball bearing design eliminates much of the end play of typical motor shafts, and allows for more consistent air flow to the combustion head.
- Automatic thermal overload protection system – far more tolerant of overloads than manual reset configurations. Automatic reset eliminates nuisance service calls caused by manual overload reset switch failures and overloads due to temporary voltage fluctuations.
- The motor capacitor is located for convenient mounting to any burner with or without an electrical box over the motor.
- Electrical leads are long enough for easy installation on any manufacturer's burner.

**Operation**

- The superior design and construction of the Carlin PSC motor allow for more consistent airflow to the combustion head of the burner.

**NOTICE** As with any component change on a burner, when installing the Carlin PSC motor you should expect performance changes to the burner. The installing technician must perform a combustion test to determine how the airflow to the burner was affected by the new motor. The Carlin PSC motor will usually provide more airflow through the burner than a typical split phase motor.

- Carlin PSC motors use less than half the starting amps and have significantly lower running amps.
- You will notice a significant reduction in mechanical noise emission from the Carlin PSC motor compared to a typical split phase motor.

**Troubleshooting**

**To check the capacitor operation:**









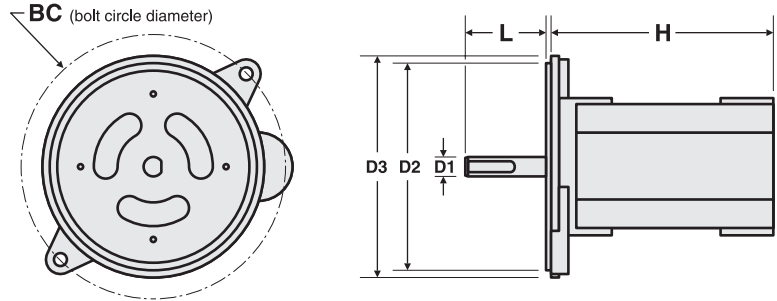





1. Disconnect electrical power to the burner.
2. Use insulated electrical pliers to carefully remove the two wires from the capacitor, one at a time.

Electrical shock hazard. Do not attempt to reinstall a capacitor removed from use until you have followed the procedure below to remove any stored charge. Handle the capacitor with care, avoiding contact with the terminals. Failure to comply could result in severe personal injury or death.

3. You must discharge the capacitor in case it holds any stored charge. Use a shorting bar if available, specifically designed for this purpose. (Do not attempt to use a screwdriver or any other device.) Connect the shorting bar to one capacitor terminal and lay the other end on the other terminal. If there is a residual charge, a spark will occur. Keep your hands away from the terminals. Do not discharge the capacitor if there are flammable liquids or vapors near your work area. An explosion could occur.
4. You will need an ohmmeter, preferably a VOM (analog meter). Digital meters may not respond quickly enough to resistance changes. Connect one meter lead to each of the capacitor terminals. The meter should show to a non-infinite reading immediately and then rapidly increase to an infinity reading (within about a second). If the meter stays on a non-infinite reading, the capacitor has an open circuit. If the meter reads a constant zero ohm reading, the capacitor has a short. Replace the capacitor if either of these conditions occurs.
5. To order replacements, see table on front page for part numbers of motors and capacitors.

**Dimensions (inches)**



| Part Number   | Rotation   | H           | L    | BC    |
|---------------|--|-------------|------|-------|
| 98022         |       | 4.29        | 1.85 | 6.75  |
|               |  | D1          | D2   | D3    |
| 98611 / 98866 |       | 4.29 / 4.69 | 1.85 | 7.25  |
|               |  | D1          | D2   | D3    |
| 98627         |   | 4.29        | 1.85 | 6.75  |
|               |  | D1          | D2   | D3    |
| 98628         |   | 4.29        | 0.74 | 5.125 |
|               |  | D1          | D2   | D3    |
| 98629         |   | 3.52        | 1.14 | 6.75  |
|               |  | D1          | D2   | D3    |
| 98630         |   | 4.73        | 1.85 | 7.25  |
|               |  | D1          | D2   | D3    |
| 99220         |   | 4.69        | 1.85 | 7.25  |
|               |  | D1          | D2   | D3    |